

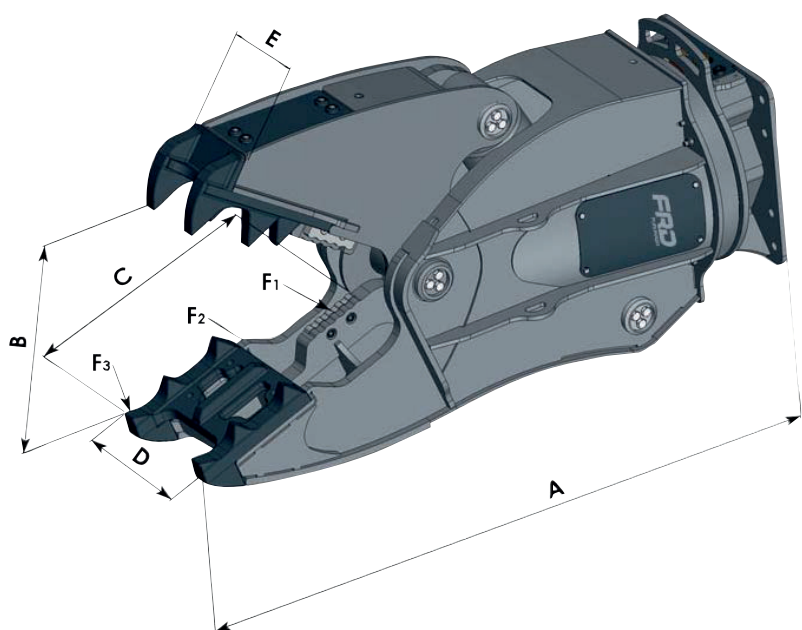







FURUKAWA - VM60ER



Specificaties		VM60ER
A	mm	3415
B	mm	1285
C	mm	1280
D	mm	540
E	mm	480
F1	kN	5000
F2	kN	4100
F3	kN	1750
	mm	300
	l/min	50
	bar	120
	l/min	400 - 500
	bar	350
	kg	5650
	t	50 - 70

